



Aromasteam

SERENE

Owners Manual

WARNING

Findings in the "Journal of the American Medical Association" show that women who are planning a pregnancy or who are experiencing the first few months of pregnancy should avoid hot tubs and saunas.

Please consult your physician before using the AromaSteam Serene aromatic steam capsule if you are pregnant or think you may be.

For easy reference please complete any missing information:

Purchase Date: _____

Serial # _____

Dealer Name: _____

Dealer Phone: _____

INTRODUCTION

Hello! Thank you for purchasing your AromaSteam Serene Aromatherapy Steam Capsule, we hope that you will enjoy it for many years to come.

We have included several important pieces of information that we encourage you to read carefully before using your product for the first time. Please keep this instruction manual safe for future reference.

The story of the AromaSteam dates back to 1990 where the inventors, two engineers from Yorkshire, England first struck on the idea of a portable steam unit where the wall and door supports the body of the unit. At that time the AromaSteam had primitive components and design ideas but the main features that make this product unique were in place.

The AromaSteam is covered by several design patents and trademarks to ensure that the AromaSteam can continue to be developed and remain at the forefront of Steam design.

The product was first sold in Japan now over 10 years ago. Since that time the product has undergone several reincarnations to reach the AromaSteam Serene that you have today, fully digital, advanced manufacturing techniques and 20,000 satisfied customers, in twenty countries and on 5 continents. Enjoy!!

CONTENTS

		Page
(I)	Diagram of your AromaSteam Serene	4
(II)	Safety Instructions	5
(III)	Manufacturer's Precautions	7
(IV)	Selecting and preparing a suitable location for your Aromasteam	10
(V)	Setting up your AromaSteam Serene	11
(VI)	Operating Instructions for your Serene	17
(VII)	Care, Cleaning and Maintenance of your Serene	19
(VIII)	Storage of your AromaSteam Serene	20
(IX)	Use of Aromatherapy Oils	21

(I) The AromaSteam Serene - Aromatic Steam Capsule

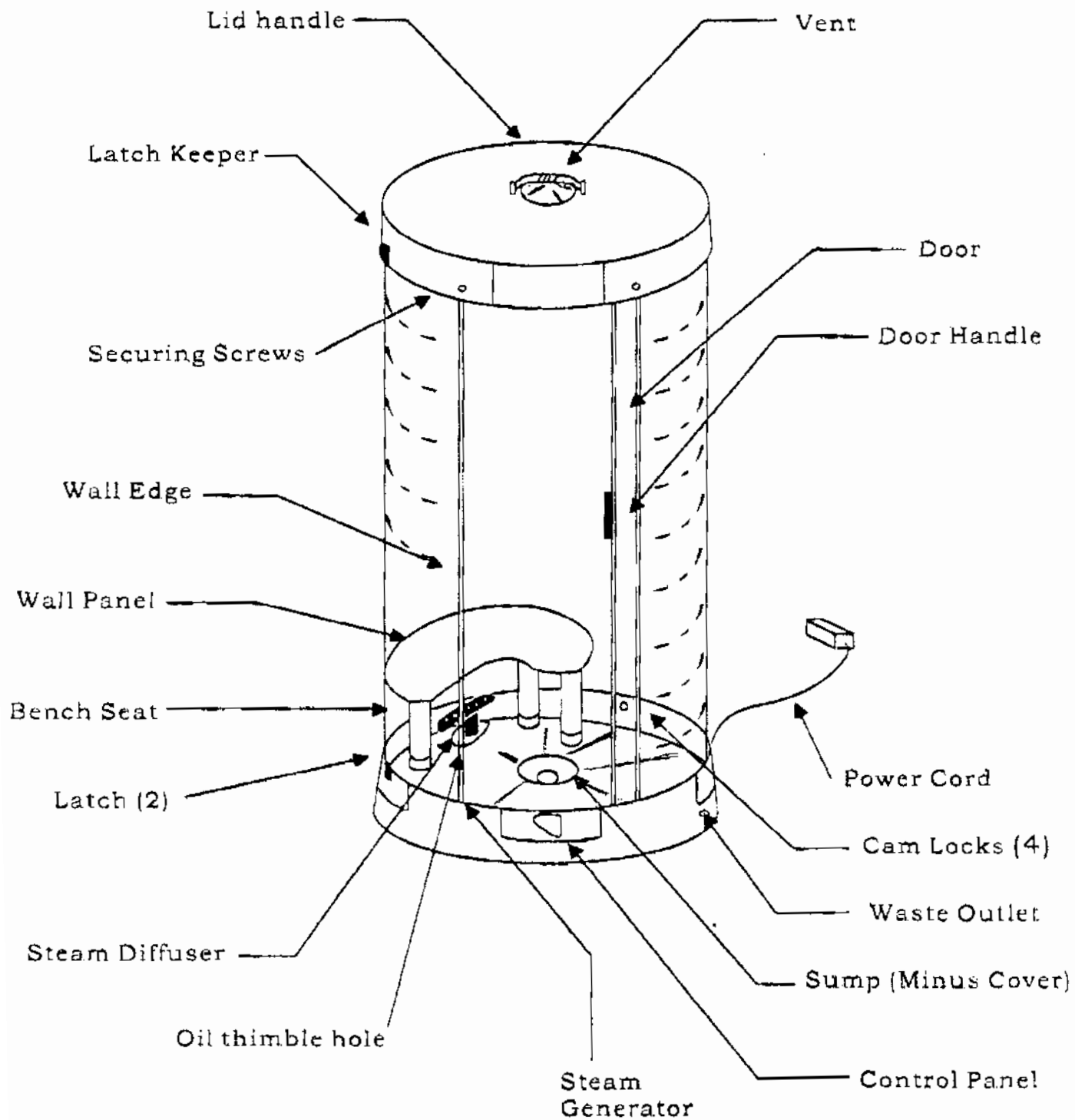

(II) SAFETY INSTRUCTIONS

The following instructions are required to be included in this manual as part of the safety listing of this unit. They include important safety information and we strongly encourage you to read and apply them.

IMPORTANT SAFETY INSTRUCTIONS

When installing and using this electrical equipment, basic safety precautions should always be followed including the following:

READ AND FOLLOW ALL INSTRUCTIONS

1. **Indoor use only** - This unit is not intended for outdoor use.
2. **Children** - To reduce the risk of injury, do not permit children to use this product unless they are closely supervised at all times.
3. **Power**
 - A) Replace damaged power cord immediately.
 - B) Do not bury cord.
 - C) Connect to a grounded, grounding type receptacle only.

4. **Installation Location**

Install at least 5 feet (1.5 m) from all metal surfaces.

Do not permit any electric appliance such as a light, telephone, radio, television, or hair dryer within 5 feet (1.5 m) of your AromaSteam.

5. **Electrical Storm Precaution**

Do not use the unit during an electrical storm, as there is a remote risk of shock.

6. **Temperature Setting**

The air temperature in the AromaSteam should never exceed 50° C (122°F).

Temperatures between 40°C (104°F) and 50° C are considered safe for a healthy adult.

Lower temperatures are recommended for children and when exposures exceed 10 minutes.

7. **Pregnancy Precaution**

Since excessive body temperatures have a high potential for causing fetal damage during the early months of pregnancy, women who are planning a pregnancy or who are experiencing the first few months of pregnancy should avoid hot tubs and saunas or limit exposure temperature to 38° C (100° F).

8. The use of **alcohol, drugs or medication** before or during spa use may lead to unconsciousness.

9. **Obesity, heart Disease high blood pressure or Circulatory system problems** suffering persons should consult a physician before using the AromaSteam.

10. **Person on medication should consult a physician before using the AromaSteam** since some medication may induce drowsiness while other medication may affect heart rate, blood pressure, and circulation.

11. People with **infectious diseases** should not use the AromaSteam.

12. **Entering the AromaSteam** To avoid injury exercise care when entering or exiting the AromaSteam.

13. **Strenuous exercise:** Do not use the AromaSteam immediately following strenuous exercise.

14. **Prolonged use** of the steam spa may be injurious to your health.

SAVE THESE INSTRUCTIONS

(III) MANUFACTURER'S PRECAUTIONS

In addition to the required safety instructions printed on page 2,3 & 4, these additional warnings have been assembled to help you enjoy your AromaSteam Serene Aromatic Steam Capsule.

Reading and understanding these warnings will allow you to reduce the risk of causing inadvertent damage to your Serene aromatic steam capsule, your surroundings or yourself.

Electrical Safety

1. **Always unplug the unit from the wall outlet when it is not being used**
 - Unplug it after use, and plug it back in when ready to use again.
 - Do not leave the unit unattended when it is plugged in.

2. **Handle the product gently**
 - The components inside may suffer damage if the unit is dropped.

3. **Protect the power cord**
 - Do not rest objects on top of the cord
 - Do not locate it where it might get damaged by foot traffic.

4. **Dry your hands before handling electrical controls**
 - Never un-plug the power cord, nor adjust the controls with wet hands or when you have wet bare feet. A danger of electrical shock exists.

High Temperature

1. Pregnancy Precaution

- women who are planning a pregnancy or who are experiencing the first few months of pregnancy should avoid hot tubs and saunas.
- Consult your physician before using the AromaSteam Serene aromatic steam capsule if you are pregnant or think you may be.

2. Never sleep in a functioning unit

3. Do not overfill the water pot

- Fill up only to the bottom of the level indicator.
- Overfilling can result in water being boiled up onto the floor of the unit, possibly damaging the unit or burning the users' feet.

4. Hyperthermia danger

- Prolonged exposure to hot moisture saturated air may induce hyperthermia.
- Hyperthermia occurs when the internal temperature of the body reaches a level several degrees above the normal body temperature of 37°C (98.6°F).
- Symptoms of hyperthermia include dizziness, lethargy, drowsiness, and fainting.
- The effects of hyperthermia include failure to perceive heat, failure to recognize the need to exit unawareness of impending hazard, fetal damage in pregnant women, physical inability to exit the spa, and unconsciousness.

Avoid Alcohol, Drugs or medication

- The use of alcohol, drugs or medication can greatly increase the risk of hyperthermia.

Aromatherapy Oils

1. **Keep out of reach of children**
 - Use only per the instructions, they are potent highly concentrated essential oils.
2. **Use a maximum of 6 drops in the thimble per instructions**
3. **Do not apply pure to skin, or take internally. Keep from contact with eyes**
4. **Discontinue use of an Aromatherapy oil if the oil causes an unpleasant reaction**
5. **Handle oils carefully**
 - Do not spill the Aromatherapy oils, They can cause damage to plastic, wood or other surfaces including those in the spa.

(IV) SELECTING AND PREPARING A SUITABLE LOCATION FOR YOUR AROMASTEAM

Most any indoor location is suitable for the AromaSteam Serene Aromatic Steam Capsule.

Factors to consider in choosing the best location are:

1. **Proximity to power**
 - You need to be within 6 to 10 feet of a suitable outlet. Use of an extension cord is considered unsafe.
2. **Protect from water spray**
 - The unit is not designed for water spray from a shower nor outdoor exposure to rain, sprinklers etc.
3. **Humidity and moisture**
 - The unit should be placed in an area that can stand excess humidity and moisture.
 - A bathroom or kitchen or any similar type area with windows, or exhaust fans to remove the steam that escapes from the unit during use, and a floor that can stand getting wet is best.
 - It is normal to get some water on the floor unless one is extremely careful getting out of the unit when wet and when filling and cleaning the unit.
4. **Convenience**
 - Proximity to a shower and changing area is convenient.
5. **Structure**
 - A flat smooth sturdy floor surface is necessary, but there are no special restrictions due to the weight of the unit.

(V) SETTING UP YOUR AROMASTEAM SERENE

1. **Open all the boxes** and check for all the necessary parts. Use the assembly drawing (page 3) to help identify parts and organize the process.
2. **Separate** all the components.
3. **Position** the Base so that the water pot is on the left and power cord is at the back.
4. Carefully **Remove Straps from rolled up Wall and Door**, while letting Wall unroll. The Wall is the larger panel Store the Strap for future use.
5. **Fit Wall around the inside rim of the Base**, the large holes at the lower edge, and with the angles at the edges of the Wall looking outwards, the opening facing front.

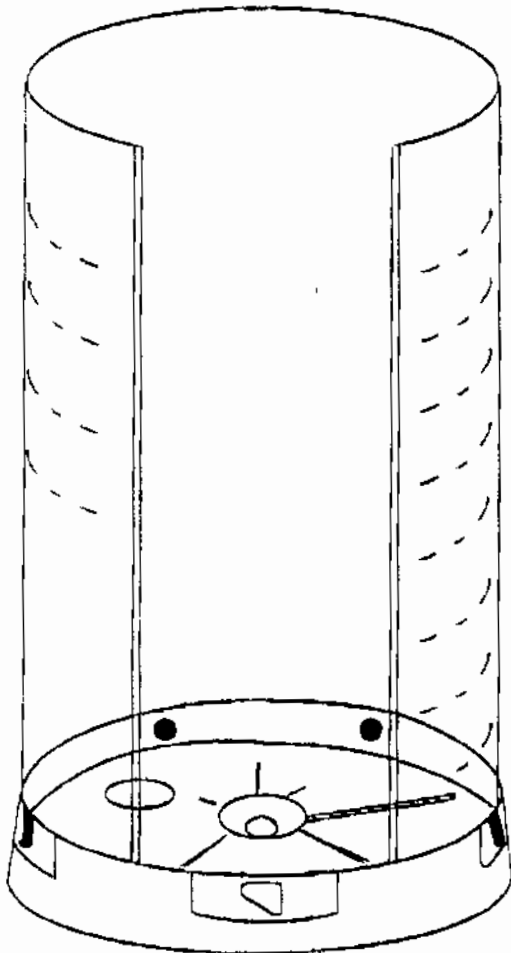

Peel back the protective film from the lower outer edge of the Wall where it is in contact with the inside rim of the Base.

6. **Line up the large holes around the bottom of the Wall** with the rotating Cams around the inside of the rim of the Base. Starting with the center Cams, push the Wall panel over each Cam in turn and lock it down with a $\frac{1}{4}$ to $\frac{1}{2}$ turn of each cam
7. **Position the Door in the gap** in the Wall. Position the Door such that the small door handle is on the left side of the Door (looking at the front of the unit from the outside) and the flange of the edge angle piece on the right side of the door is aiming inwards toward the centre of the unit.

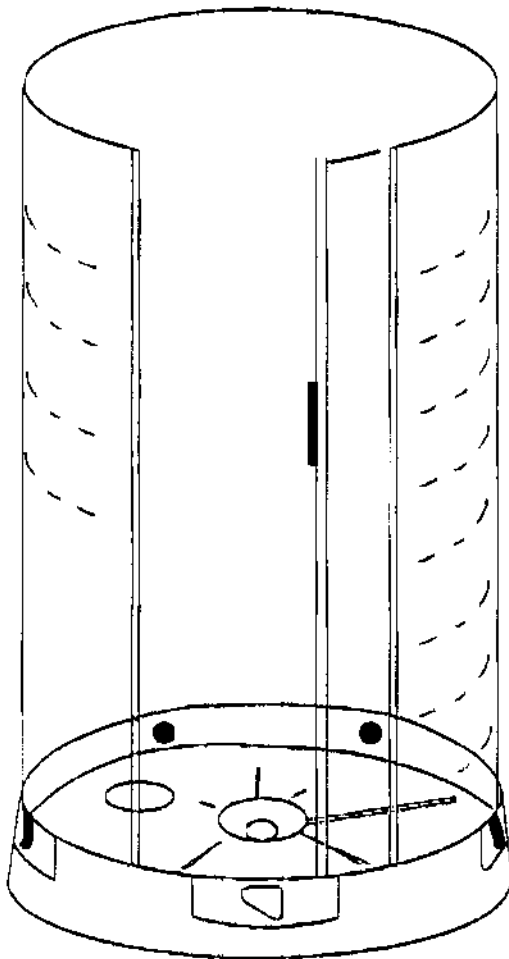

Fit the bottom edge of the Door into the groove in the outer edge of the Base, but inside the Wall.

The door should slide easily at this point, when held upright. Slide the Door rightwards to the open position.

8. **Place the Lid atop the upstanding Wall and Door** with the large name plate label on the Lid facing forward. The Wall and Door fit up into the groove just inside the edge of the Lid.

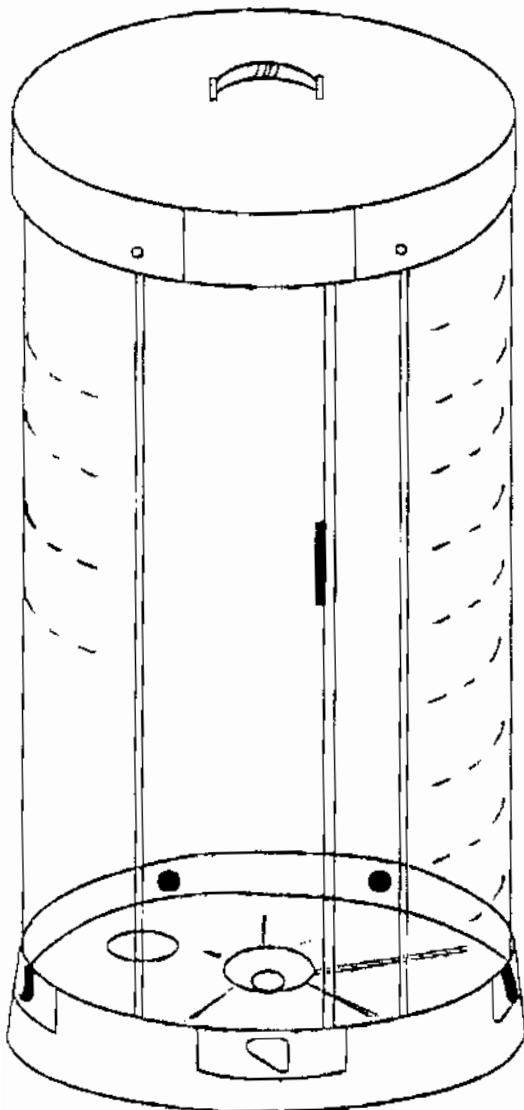

9. **Align the Wall and Lid** so that the securing means are aligned then attach securing screws. The Wall needs to be held flat against the rim of the lid to align the screw hole.

Once satisfied that the parts are properly oriented, remove the Lid securing means and the Lid. Peel off the protective film over the Wall and Door and then carefully reassemble the Lid.

10. Assemble bench seat as shown

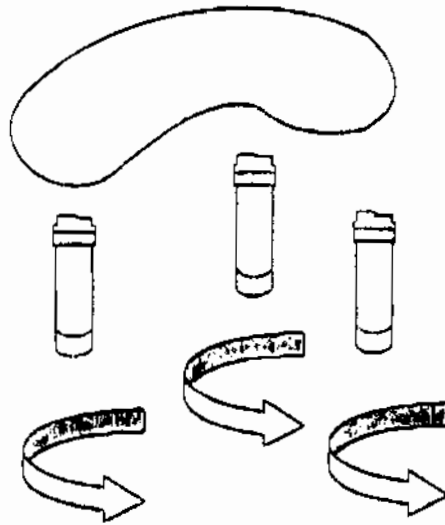

11. Carefully orientate the bench so that the rear locking cams and the wall line up.

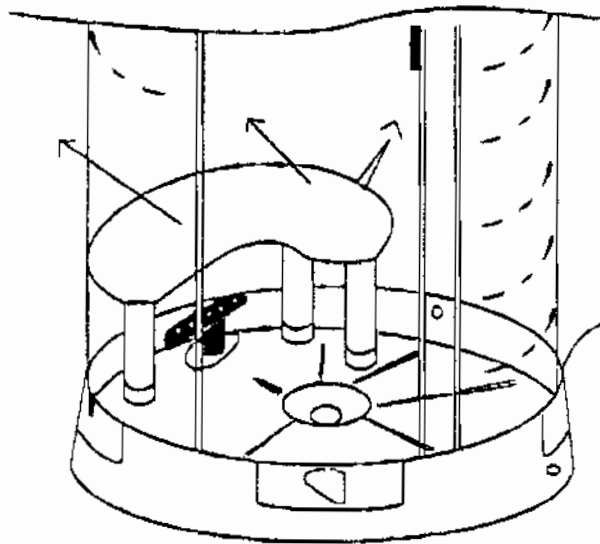

12. **Attach the cams from the outside through the wall and into the bench, fixing with a $\frac{1}{4}$ turn**

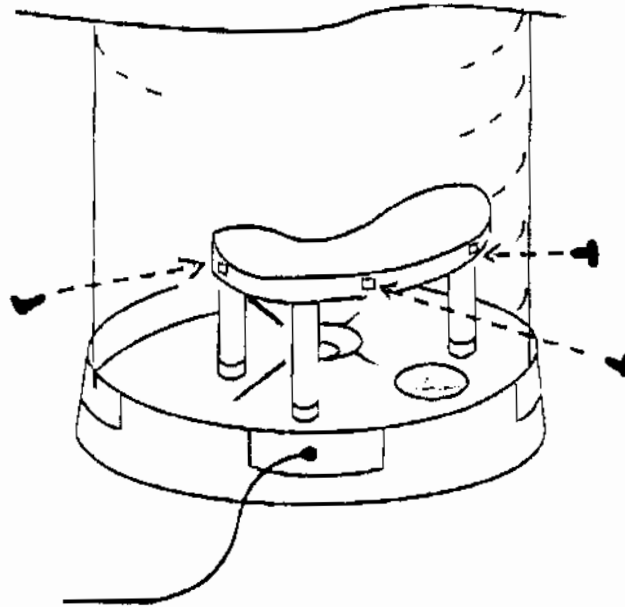

13. **Attach the steam sensor cord to the temperature sensor located at the top of the unit**

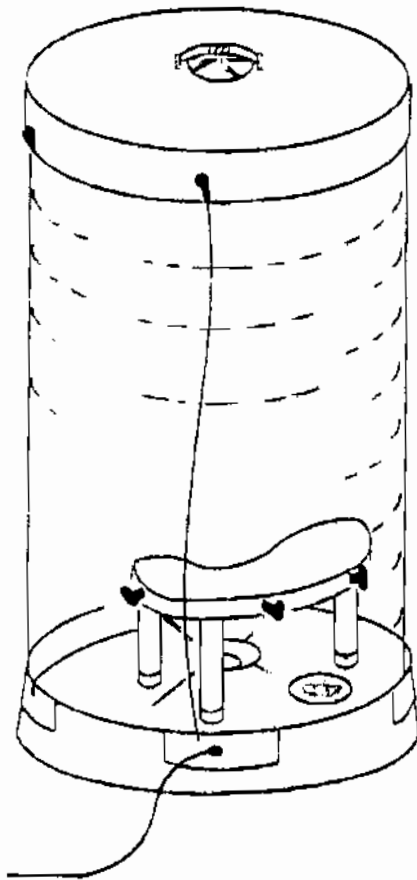

14. **Fill steam generator water pot with clean, cool distilled water** (at the rear-left of the Base) through the hole in the cover to the level indicated by the tab in the hole or about 1.5" below the rim.

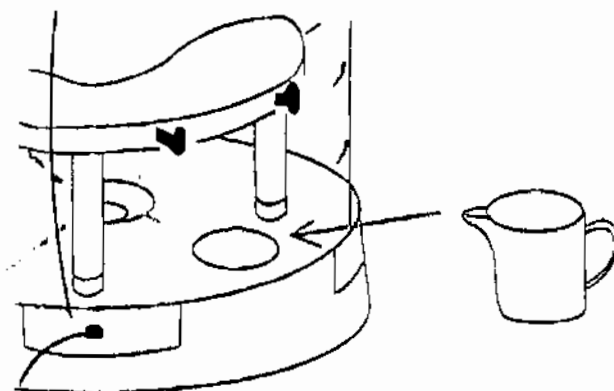

15. Place the Steam Diffuser into the hole in the water pot cover.
16. Drop recommended amount of selected Aromatherapy Oil into Thimble.
17. Place Thimble in the Thimble Holder and then in the large hole in the center of the Diffuser.

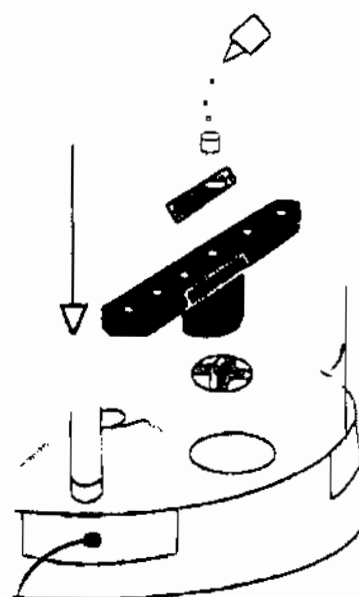

**PLEASE READ INSTRUCTION WARNING LABEL
ON THE MACHINE BEFORE USE**

Your AromaSteam Serene aromatic steam Capsule is now ready for use!

(VI) OPERATING INSTRUCTIONS FOR YOUR SERENE

1. **Fill Steam Generator** (located in the Base towards the rear of the unit) with no more than 2 1/2 pints of clean, fresh, cool distilled water (if not already filled)

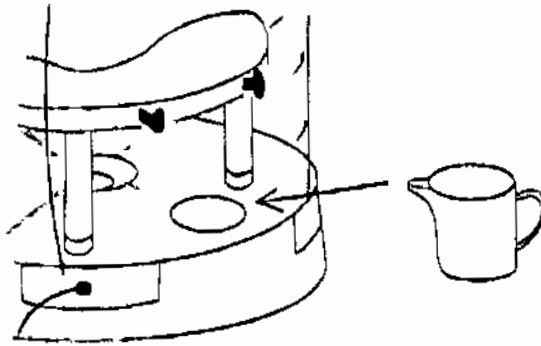

It is important that the heater element remains submerged at all times while the unit is running.

2. **Insert Steam Diffuser** and safety cover into the water pot.

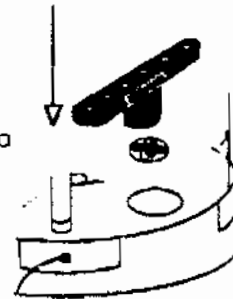

3. **Insert the Power Cord** into any standard electrical wall outlet that provides up to 15 Amps of electrical current.

4. **Add a Few Drops of Essential Oil to the thimble**, then place the thimble and holder into the diffuser.

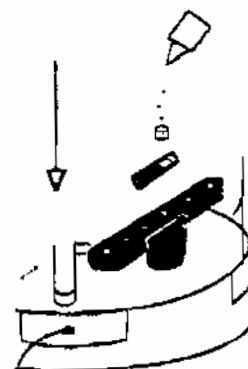

5. Setting the Program

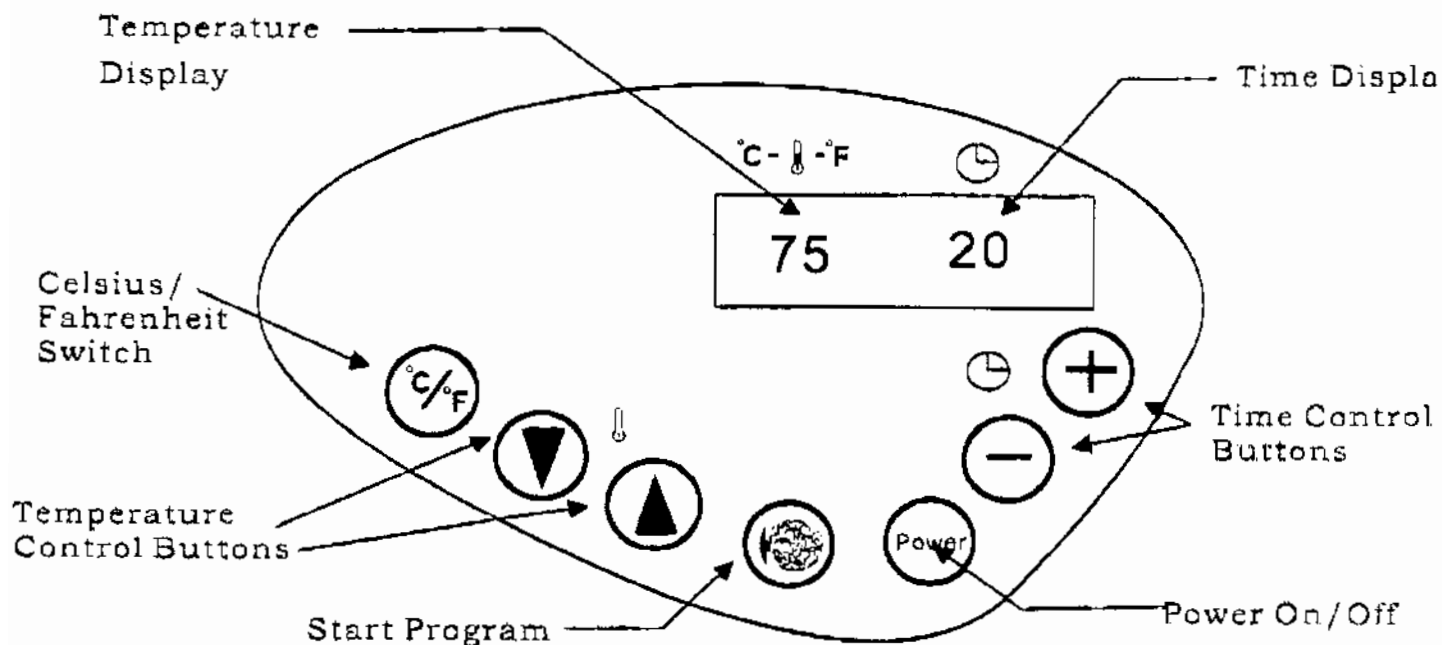

- (i) Press the Power On/Off button
- (ii) Press Celsius/Fahrenheit Switch to display temperature in Fahrenheit
- (iii) Set the temperature required using the Temperature Control Buttons
- (iv) Press the Start Program button
- (v) Set the Time Period Required using the Time Control Buttons

N.B! When altering the temperature setting, the panel is designed to display the new set temperature for 5 seconds, before reverting to the actual temperature within the unit.

6. **Close the door and the roof vent** and let the unit warm up (5-10 minutes)
7. When the **required temperature is reached** step into the unit and enjoy. The roof vent and the temperature control can be used to adjust the steam intensity.

CAUTION - OUT OF WATER

8. If the unit runs out of water, a protection circuit in the heater will shut it off and on, keeping it from overheating. Shut the power off, let the heater cool for a few minutes and then add more water.

RECOMMENDED SESSION LENGTH IS 20 MINUTES

(VII) CARE, CLEANING AND MAINTENANCE OF YOUR SERENE

1. Always unplug the unit after use.
2. Empty the water pot after use.
IMPORTANT - Wait at least 1 hour for the water to cool before emptying the water pot.
3. Empty the Sump by removing the cover and pushing the drain plug to the up position. Ensure that at the waste outlet on the front of the unit you have a suitable receptacle to receive the water.
4. It is recommended that periodically the waste system is flushed through with mild detergent.
5. Clean the base of the unit with a small amount of mild detergent and a soft cloth or sponge
6. Clean the wall & door material only when necessary. Use either
 - A) a non-ammonia based glass cleaner with a soft cloth
 - B) rinse with lukewarm water, wash gently with mild soap or detergent and lukewarm water, using a soft cloth, then rinse again. Dry with a soft cloth or moist cellulose sponge to prevent spotting.

DO NOT SCRUB OR USE ABRASIVES!

(VIII) STORAGE OF YOUR AROMATEAM SERENE

Once the unit is clean and dry, it is easy to store.

1. **Roll up the Wall and Door and secure with the strap.**
2. **Unscrew bench legs.**
3. **Place the Lid over the base and align the Latches.** Unfold the Latches and hook latch Keeper on the Lid with the Latch, then fold down the Latch to secure for easy carrying and secure storage.
4. **Make sure the Oils all have their caps securely Fastened,** and place them in the presentation box provided, out of the reach of children and out of the direct sunlight.

(IX)USE OF AROMATHERAPY OILS

Aromatherapy Oils are the aromatic essences of flowers, leaves, spices, fruits, woods, roots and more. They are fragrant, highly concentrated, volatile extracts of special natural plants and been used for centuries by people in the quest for health and well-being.

Synergies are blends of oils which are chosen to complement each other. The synergy comes as each oil supports the theme of the blend and fills in the spectrum of strengths and volatilities.

The specially formulated synergies included with your unit are specially blended for easy use with the AromaSteam Serene aromatic steam capsule. They are 100% pure, essential oils.

To add the Aromatherapy experience to your steam session, simply add 3- drops of essential oil to a stainless steel thimble, and place in the mating hole in the black steam diffuser. Leave the thimble holder in place to help remove the thimble when hot. Clean the thimble with iso propyl (rubbing) alcohol before reuse.

As these oils are potent aromatic substances, you need to observe the cautions below:

- Keep out of the reach of children
- Do not apply pure to the skin
- Do not take internally
- Keep out of and away from eyes
- Do not spill them on non-impervious surfaces
- Do not spill them on the unit.

MADE IN CHINA, Under licence of Vanity Fayre International Ltd.
Protected by US patent No 5,416,931, British Patent No GB2241165.
The distinctive design of the AromaSteam Serene is the exclusive trademark and symbol of identification of Vanity Fayre International Ltd